

Uniden | A World Without Wires®

UNIDEN
CORDLESS
PHONES



DECT2060 Series

OWNER'S MANUAL

Table of Contents

Welcome	4	Basic Setup	17
Accessibility	4	Selecting a Language	17
Terminology Used in this Manual	5	Activating Personal Ring.....	17
Manual Conventions	5	Activating the Key Touch Tone.....	18
Product Overview	6	Expanding Your Phone	19
Features.....	6	Adding Accessory Handsets	19
Parts of the Phone	7	Using Multiple Bases	20
Using the Interface	9	Setting Up the Phonebook	22
Reading the Display.....	9	Creating Phonebook Entries.....	22
Using the Four-way Function Key.....	10	Finding a Phonebook Entry	23
Using the Handset Menus	10	Editing an Existing Phonebook Entry.....	23
Entering Text from Your Handset	11	Storing Caller ID or Redial Numbers in the Phonebook	24
Installing the Phone	12	Deleting Phonebook Entries	24
Choosing the Best Location	12	Copying Phonebook Entries to Another Handset ..	25
Installing the Battery	13	Using the Voice Mail Service	26
Installing the Belt Clip	14	Setting the Voice Mail Signaling Tone.....	26
Connecting the Base and Charging the Handset ..	14	Programming One-Touch Voice Mail Access	27
Connecting to the Phone Line	15	Resetting the Voice Mail Waiting Indicator.....	27
Changing the Dial Mode	15		
Wall Mounting the Base	16		

Customizing Your Phone	28	Finding a Lost Handset	35
Changing the Handset Banner	28	Using Hold, Conference and Transfer	35
Selecting a Ring Tone	28	Placing a Call on Hold	35
Activating AutoTalk.....	29	Conferencing	36
Activating Any Key Answer	29	Transferring a Call	36
Using Your Phone	30	Using Special Features	37
Making a Call from the Phonebook.....	31	Privacy Mode	37
Chain Dialing from the Phonebook.....	31	Using the Intercom.....	37
Switching to the Handset Speakerphone		Muting the Ringer (One call only)	38
During a Call	31	Muting the Microphone	38
Using Caller ID, Call Waiting, and Redial Lists	32	Seven-Digit Dialing	38
Using the Caller ID List	32	Tone Dialing Switch Over.....	39
Making a Call from a Caller ID Record	32	Line Mode Setup (Base only)	39
Deleting Caller ID Numbers	33	Installing the Optional Headset.....	39
Using Call Waiting.....	33	Maintenance	40
Redialing a Number	33	Specifications.....	40
Deleting a Redial Record	34	Battery Replacement and Handling	40
Adjusting the Ringer, Earpiece and		Cleaning the Battery Contacts	41
Speaker Volume	34	Low Battery Alert	41
Adjusting the Ringer Volume	34	Battery Life.....	41
Adjusting the Earpiece Volume	34	Power Failures.....	41
Adjusting the Speaker Volume.....	34		
Adjusting the Audio Tone	35		

Troubleshooting	42
Resetting the Handset	42
Resetting the Handset Without the Base	43
Traveling Out of Range	43
Common Issues	44
Liquid Damage	46
Precautions!	47
Rechargeable Nickel-Metal-Hydride Battery Warning	47
The FCC Wants You To Know	48
I.C. Notice	49
One Year Limited Warranty	50
Index	51
At Uniden, we'll take care of you!	54

Welcome

Thank you for purchasing a Uniden Multi-Handset phone.

Note: Illustrations in this manual are used for explanation purposes. Some illustrations in this manual may differ from the actual unit.

As an Energy Star® Partner, Uniden has determined that this product or product models meets the Energy Star® guidelines for energy efficiency. Energy Star® is a U.S. registered mark.

Uniden is a registered trademark of Uniden America Corporation.



Accessibility

Uniden provides a customer service hotline for accessibility questions. If you have a disability and need customer service assistance or if you have any questions about how Uniden's products can accommodate persons with disabilities, please call the accessibility voice/TTY line: 1-800-874-9314.

Our customer care hours as well as accessibility information can be found on our website, www.uniden.com, under the "Accessibility" link. If your call is received outside of our business hours, you can leave us a message and we will call you back.

Terminology Used in this Manual

Standby	The handset is not in use. If it is off the cradle, no line has been activated. No dial tone is present.
CID	Caller ID is available from your Telephone provider and is offered to users on a subscription basis. With this service, you will be able to see the incoming caller information such as name and phone number.
CID/CW or CIDCW	Caller ID with Call Waiting is available by subscription from your Telephone provider. With this service, you will be able to view incoming caller information while on a call with another user.
Base	The main part of the phone that connects to your phone line and lets you make and receive calls.
Charger	A cradle that comes with an accessory handset and charges the handset battery. It connects to power but does not connect to a phone line.
Accessory Handsets	Additional handsets that can register to the base, allowing you to add handsets without connecting another phone line. This base supports a total of six cordless handsets; see page 19 for Compatible Handsets.
Global Settings	This term relates to feature settings that will apply to all registered handsets and the base. These features are available by selecting "GLOBAL SETUP" in the handset menu. Only one handset can change global settings at a time, and you have to make sure the phone is not currently being used. If you have multiple bases, the different bases have each global settings; select the base before changing the global setting (see Selecting the Base on page 21).
Talk	A telephone line has been activated on the handset or base, enabling a dial tone.

Manual Conventions

This manual uses several different type styles to help you distinguish between different parts of the phone:

- **Bold** text with “[]” indicates a key or button on the phone
- ALL CAPITALS indicates text on the display, such as menu options, prompts, and confirmation messages
- **lower case bold** text indicates a status light on the phone
- **ALL CAPITALS BOLD** indicates a connection jack on the base or charger

Product Overview

Features

- 1.9GHz DECT6.0 Expandable System
- Expands up to 6 Handsets
- Caller ID/Call Waiting
- Store 30 Caller ID Numbers
- Advanced Phonebook Features:
 - Store 70 Phonebook Entries
 - Alphabetical Search
 - Personalized Ring by Party
 - Transfer Single Listing or Entire Phonebook
- Speakerphone on Handset
- 7 Ringer Options on Handset (3 Tones/4 Melodies)
- Last 5 Number Redial
- Bilingual Menu Displays
(for US models: English and Spanish,
for Canadian models: English and French)
- Call Transfer
- Conferencing
- Intercom

Parts of the Phone

The following illustrations show you all of the different parts of your phone.

Handset

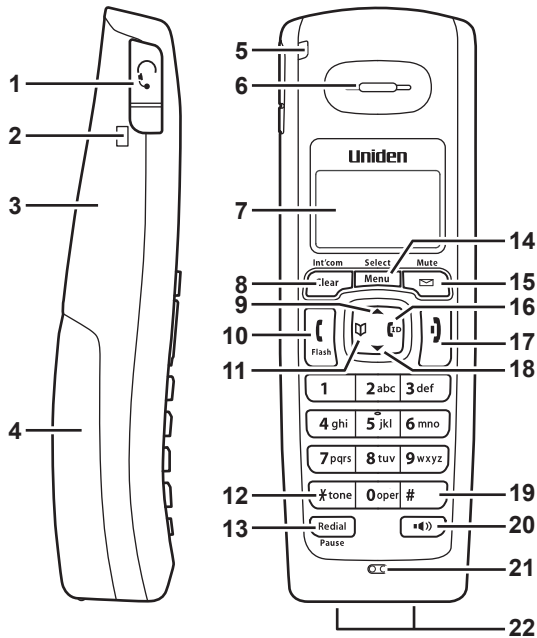

1. Headset jack cover
2. Belt clip hole
3. Speakerphone speaker and ringer
4. Handset battery compartment
5. **new message** LED
6. Handset earpiece
7. LCD display
8. **[Clear/Int'com]** key
9. **[▲]** key (up)
10. **[Flash]** key (talk/flash)
11. **[☰]** key (phonebook/left)
12. **[*/tone]** key
13. **[Redial/Pause]** key
14. **[Menu/Select]** key
15. **[Mute]** key (messages/mute)
16. **[ID]** key (caller ID/right)
17. **[⏹]** key (end call)
18. **[▼]** key (down)
19. **[#]** key
20. **[Speaker]** key (speaker)
21. Handset microphone
22. Handset charging contacts

Base

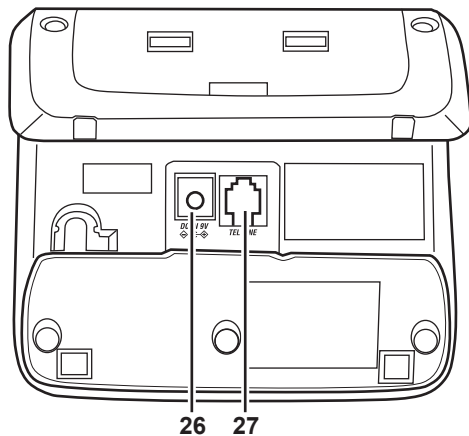
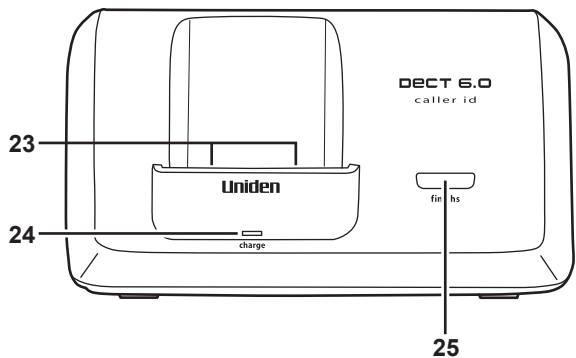







- 23. Base charging contacts
- 24. **charge** LED
- 25. **[find hs]** key (find handset)
- 26. **DC IN 9V** jack
- 27. **TEL LINE** jack

Using the Interface

Reading the Display

The handset display uses icons to tell you the status of your phone. The table below lists the icons and what they mean.

Icon	Status	Description
	Standby/Talk	The battery icon indicates the handset battery status: full, medium, low, and empty.
	Standby	The ringer off icon indicates that the ringer is turned off.
	Talk	The mute icon appears while the handset microphone is muted.
	Talk	The speaker icon appears when the handset speaker phone is in use.
	Talk	The privacy icon appears when the Privacy Mode is turned on.
	Standby	The voice mail icon appears when you have messages waiting in your voice mailbox.

The Standby Screen

When the phone is in standby, the handset display shows the following items:

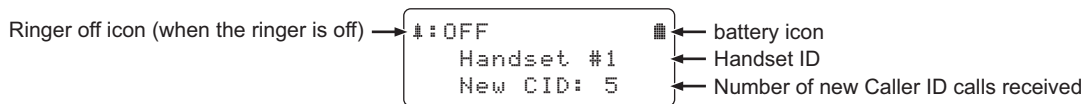

Using the Four-way Function Key

Your handset has a four-way function key that allows you to move the cursor or pointer on the display and access the most commonly used features at the touch of a button. By moving this key to the left, you open the phonebook. Move the key to the right to access Caller ID information. To use this four-way key, place your thumb over the key on the handset and move to the four positions to get the feel of how it moves and operates.

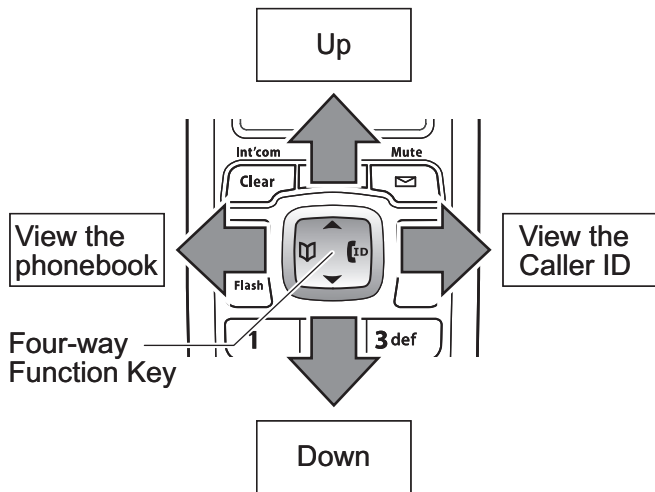

Using the Handset Menus

To open the menu, press **[Menu/Select]**. Highlight the option you want by pressing the four-way function key. This will move the cursor; the option currently highlighted has a triangle beside it. Activate the highlighted option by pressing **[Menu/Select]**. To go back to the previous screen, press **[left]** on the four-way function key. To exit the menu and return to standby, press **[*]**.

If you do not press a key within thirty seconds, the phone will time out and exit the menu.

Note: For GLOBAL SETUP menu options, make sure the line is not in use and the handsets are within range of the base.

Entering Text from Your Handset

You can use the number keypad on your handset to enter text by referring to the letters printed on each number key. When you press the number key in a text entry field, the phone displays the first letter printed on the number key. Press the number key twice to display the second letter and three times to display the third. Capital letters are displayed first, then lower case letters, and then the number on the key.

If two letters in a row use the same number key, enter the first letter, then use **[right]** on the four-way function key to move the cursor to the next position to enter the second letter.

For example, to enter the word "Movies":

- 1) Press **[6]** once to enter *M*.
- 2) Use **[right]** on the four-way function key to move the cursor to the right.
- 3) Press **[6]** six times to enter *o*.
- 4) Press **[8]** six times to enter *v*.
- 5) Press **[4]** six times to enter *i*.
- 6) Press **[3]** five times to enter *e*.
- 7) Press **[7]** eight times to enter *s*.
- 8) Press **[Menu/Select]** to end your text entry.

	Number of times key is pressed								
keys	1	2	3	4	5	6	7	8	9
1	1								
2 abc	A	B	C	a	b	c	2		
3 def	D	E	F	d	e	f	3		
4 ghi	G	H	I	g	h	i	4		
5 jkl	J	K	L	j	k	l	5		
6 mno	M	N	O	m	n	o	6		
7 pqrs	P	Q	R	S	p	q	r	s	7
8 tuv	T	U	V	t	u	v	8		
9 wxyz	W	X	Y	Z	w	x	y	z	9
0 oper	&	()	<	>	/	(blank)	--	--
	.	,	:	?	!	@	'	"	*
	#	0							

If you make a mistake while entering a name, use **[right]** or **[left]** on the four-way function key to move the cursor to the incorrect character. Press **[Clear/Int'com]** to erase the wrong character, and then enter the correct character. To delete all characters, press and hold **[Clear/Int'com]**.

Note: When you enter the text, you can also use **[#]** to move the cursor to right and **[*/tone]** to move the cursor to left.

Installing the Phone

Choosing the Best Location

When choosing a location for your new phone, here are some important guidelines you should consider:

- The location should be close to both a phone jack and a continuous power outlet (one which is not connected to a switch).
- For optimum range and reception, place the base in an open area, as high as possible.
- If your home has wired alarm equipment connected to a phone line, be sure that installing the system does not disable your alarm equipment. If you have questions about what will disable alarm equipment, contact your telephone company or a qualified installer.

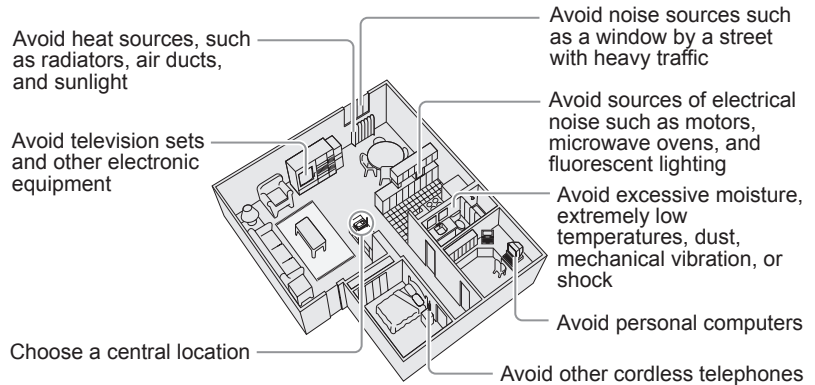

Note: For maximum range:

- Keep both the base and handset antennas free of obstruction.
- When the handset is not in use, place the handset in an upright position.
- Metal and reinforced concrete may affect cordless telephone performance.

Installing the Battery

Use only the Uniden BT-1008 rechargeable battery pack supplied with your cordless telephone.

Follow the steps below to install the handset battery.

- 1) Press in on the handset battery case cover (use the finger indentation for a better grip) and slide the cover downward to remove.
- 2) Plug the battery cable into the battery jack. Be sure to match the red and black wires to the label near the jack. The cable should snap into place. Gently pull on the battery cable. If the battery connector comes loose, try connecting again until the battery snaps into place.
- 3) Place the battery case cover back on the handset and slide it upwards until it clicks into place.

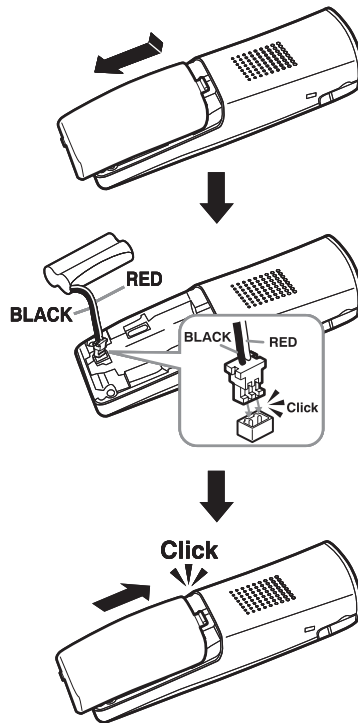

Installing the Belt Clip

Line up the holes on each side of the handset. To attach the belt clip, insert into the holes on each side of the handset. Press down until it clicks.

To remove the belt clip, pull either side of the belt clip to release the tabs from the holes.

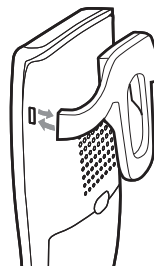

Connecting the Base and Charging the Handset

- 1) Route the AC adapter cord through the “LOOP” of base’s back as shown.
- 2) Connect the AC adapter to the **DC IN 9V** jack.

CAUTION: To avoid risk of fire and shock, only use the Uniden AD-800 AC adapter.

- 3) Connect the AC adapter to a standard 120V AC wall outlet. **DO NOT** use an AC outlet controlled by a wall switch.
- 4) Place the handset in the base with the LCD screen facing forward.
- 5) Make sure that the **charge** LED illuminates. If the LED does not illuminate, check to see that the AC adapter is plugged in and the handset makes good contact with the charging contacts.
- 6) Charge your handset at least 15 to 20 hours before plugging into the phone line.

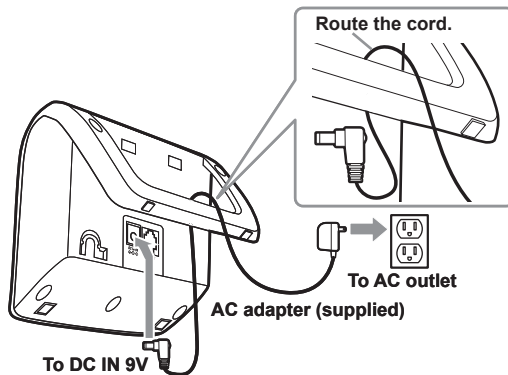

Connecting to the Phone Line

- 1) Once the battery pack is fully charged, route the telephone cord through the “LOOP” of base’s back as shown, and connect the telephone cord to the **TEL LINE** jack.
- 2) Connect the telephone cord to a telephone wall jack.

Testing the Connection

Try making a call. If your call does not connect or you cannot get a dial tone, try the following steps:

- 1) Make sure the AC adapter cord is securely connected to the **DC IN 9V** jack and a standard power outlet.
- 2) Check to make sure the battery is fully charged. (If you don't see the “battery full” icon, check to make sure the battery is properly connected).
- 3) Change the dial mode.

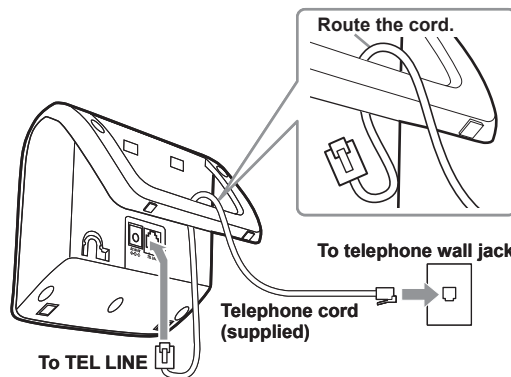

Changing the Dial Mode

Your phone can communicate with the telephone network in two different ways: tone dialing or pulse dialing. These days, most base networks use a method called tone dialing, so your phone comes programmed for tone dialing. If your phone company uses pulse dialing, you will need to change your phone's dial mode. If you don't get a dial tone or can't connect to the telephone network, please follow the steps below to modify your phone's settings:

- 1) Press **[Menu/Select]**. Select the GLOBAL SETUP menu, and then the DIAL MODE submenu.
- 2) Scroll **[▼]** to highlight PULSE.
- 3) Press **[Menu/Select]**. You will hear a confirmation tone.

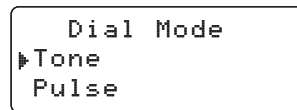

If you ever need to change the dial mode back to tone dialing, follow the same procedure, but select TONE in step 2.

Note: If you have multiple bases, select the base before changing the dial mode (see Selecting the Base on page 21).

Wall Mounting the Base

This phone can be mounted on any standard wall plate.

- 1) Snap the wall mount adapter into the notches on the base's back.
- 2) Plug the AC adapter into the **DC IN 9V** jack.
- 3) Plug the AC adapter into a standard 120V AC wall outlet.
- 4) Plug the telephone cord into the **TEL LINE** jack.
- 5) Route the telephone cord through the hole of the wall mount adapter as shown.
- 6) Plug the telephone cord into the telephone wall jack.
- 7) Align the mounting slots on the base with the mounting posts on the wall. Then push in and down until the phone is firmly seated.

Notes:

- DO NOT use an AC outlet controlled by a wall switch.
- To mount the phone directly on the wall, insert two #10 screws (minimum length of $1 \frac{3}{8}$ inches, not supplied) into the wall, $3 \frac{15}{16}$ inches apart; leave the screw heads $\frac{1}{8}$ inch away from the wall to allow room for mounting the phone. Be sure the wall is capable of supporting the weight of the phone, and use the proper type of anchoring device for the wall material. No need to route the telephone cord through the hole of the wall mount adapter when mounting directly on the wall.

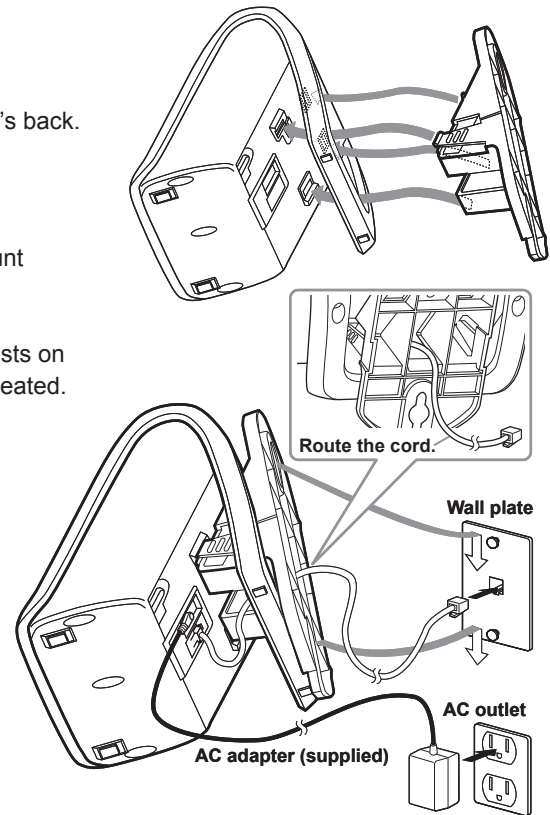

Basic Setup

Selecting a Language

Your phone supports two languages: English and Spanish for US models or English and French for Canadian models. Once you select a language, the menus on the handset will display in that language. The default language is English.

- 1) Press **[Menu/Select]**. Select the HANDSET SETUP menu, and then the HANDSET LANGUAGE submenu.
- 2) Move the cursor to choose a language.
for US models: Choose ENGLISH or ESPAÑOL (Spanish).
for Canadian models: Choose ENGLISH or FRANÇAIS (French).
- 3) Press **[Menu/Select]**. You will hear a confirmation tone.

```
Handset Language
▶English
Español
```

for US models

```
Handset Language
▶English
Français
```

for Canadian models

Activating Personal Ring

You can assign special ringer tones to anyone in your phonebook. When your phone gets a call, it looks up the Caller ID information in your phonebook. If you've assigned a personal ringer to that number, the phone uses it so you know who is calling. To turn the personal ringing on or off, follow these steps:

- 1) Press **[Menu/Select]**. Select the HANDSET SETUP menu, and then the PERSONAL RING submenu.
- 2) Move the cursor to select ON or OFF.
- 3) Press **[Menu/Select]**. You will hear a confirmation tone.

```
Personal Ring
▶On
Off
```

Activating the Key Touch Tone

Key Touch Tone is the tone your keypad makes when keys are pressed. You can turn this tone on or off.

- 1) Press **[Menu/Select]**. Select the HANDSET SETUP menu, and then the KEY TOUCH TONE submenu.
- 2) Move the cursor to select ON or OFF.
- 3) Press **[Menu/Select]**. You will hear a confirmation tone.

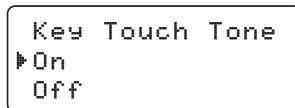

Expanding Your Phone

Adding Accessory Handsets

Your phone supports a total of six cordless handsets. You can now place a fully-featured cordless handset anywhere AC power is available to connect the handset charger. All the handsets ring when a call is received.

Compatible Handsets

Your phone is compatible with the **DCX200**. If you purchased an accessory handset separately, you must register the handset to the base before use. Accessory handsets will not operate until they are registered.

Charging Accessory Handsets

The handset's battery recharges automatically when the handset is placed in the charger.

- 1) Use the supplied AC adapter (AD-0005) to connect the **DC IN 9V** jack to a standard 120V AC outlet.
- 2) Set the charger on a desk or tabletop, and place the handset in the charger with the LCD screen facing forward.
- 3) Make sure that the **charge** LED illuminates. If the LED does not illuminate, check to see that the AC adapter is plugged in and the handset makes good contact with the charging contacts.
- 4) Charge the handset battery pack for at least 15-20 hours before using your new handset for the first time.

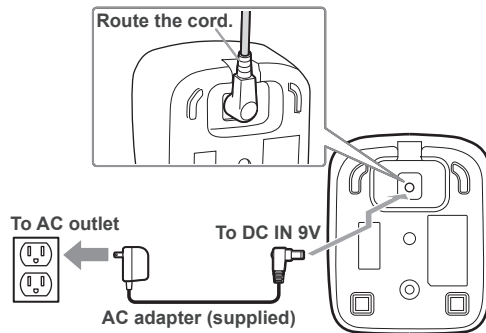

Caution: Use only the Uniden AD-0005 adapter.

Registering DCX200 Accessory Handsets

If you purchase an accessory handset, you need to register the handset before use. Handset(s) supplied in the box with the base are pre-registered at the factory. When charged, pre-registered handsets display a handset ID number. Handsets that have not been registered display:



To register an accessory handset:

- 1) Charge the handset for 15-20 hours.
- 2) Place the handset in the main telephone base cradle to initiate registration. HANDSET REGISTERING will appear in the LCD.
- 3) Wait approximately thirty seconds, "REGISTRATION COMPLETE" will be displayed to indicate the handset has been registered to the base and a handset ID will be automatically assigned.

If REGISTRATION FAILED appears in the LCD, please try these steps again.

Note: If an accessory handset has ever been registered to a base, you must reset the handset before you can register it to a new base. See Resetting the Handset on page 42.

Using Multiple Bases

DCX200 handsets and the handsets supplied with your phone can be registered to a total of four different DECT2060 or DECT2080 bases. Once your handset is registered to more than one base, you can set the handset to search automatically the available base, or you can select manually which base the handset should connect to (for example, if you have one base with an answering machine, you can tell the handset to connect that base to check messages).

Registering the Handset to Another Base

To register a handset to another base:

- 1) Make sure the handset battery is fully charged.
- 2) On the base, disconnect the base AC adapter. Then press and hold **[find hs]** while you reconnect the adapter. Keep pressing **[find hs]** until the **charge** LED starts to blink.
- 3) On the handset, Press **[Menu/Select]**. Select the REGISTER BASE menu. HANDSET REGISTERING will appear in the display.
- 4) Wait approximately thirty seconds. "REGISTRATION COMPLETE" will be displayed to indicate the handset has been registered to the base and a handset ID will be automatically assigned.

If REGISTRATION FAILED appears in the LCD, please try these steps again.

Selecting the Base

When your handset is registered to another base, it will automatically connect to the base. A base ID (that is for the handset only) will be assigned in the order of registration. You can either select a base you want to use manually, or set to AUTO. If you set to AUTO, when the handset comes out of range, it searches automatically the available base in order of base ID.

- 1) With the phone in standby, press **[Menu/Select]**. Select the HANDSET SETUP menu, and then the SELECT BASE submenu.
- 2) Move the cursor to select the base you want to connect to, or choose AUTO to have the handset automatically select the base.
- 3) Press **[Menu/Select]**. SEARCHING will appear in the display.
- 4) When the base is found, the handset will return to standby. If the base is not found, "SEARCHING" continues to appear. You can repeat the procedure listed above to return back to the original connection or to find the different base.

Notes: • You cannot change bases during a call.

- To confirm which bases the handset is registered to, open the SELECT BASE submenu and use **[▲]** and **[▼]** to scroll through the list. Press **[j]** to close the list and return to standby.

Setting Up the Phonebook

Your handset can store up to seventy names and numbers in your phonebook. When all the phonebook entries are full, you will hear a beep and MEMORY FULL appears. You cannot store any additional names and numbers unless you delete some of the existing ones.

You can also use the phonebook entries to store a group of numbers (up to twenty digits) that you may need to enter once your call connects. This is referred to as chain dialing. See Chain Dialing from the Phonebook on page 31.

Creating Phonebook Entries

To store names and numbers in your phonebook, please follow these steps:

1) When the phone is in standby mode, press [] (on the left side of the four-way key).

2) To create a new phonebook entry, press [Menu/Select]. Select the CREATE NEW menu. EDIT NAME appears.

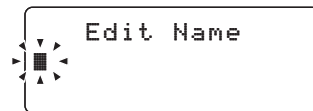

3) **Enter the name for this entry (EDIT NAME).**

Use the keypad to enter a name for this entry; the name can contain up to sixteen characters. (See Entering Text from Your Handset on page 11 for instructions on entering text.) If you do not want to enter a name for this entry, your phone will store this entry as <NO NAME>. Press [Menu/Select] when you are finished.

4) **Enter the number for this entry (EDIT NUMBER).**

Once you have stored a name, EDIT NUMBER appears next. Use the number keypad to enter the phone number; the phone number can contain up to twenty digits. If you need the phone to pause between digits when it's dialing (for example, to enter an extension or an access code), press [Redial/Pause] to insert a two-second pause. You will see a P in the display. You can also use more than one pause together if two seconds is not long enough. Each pause counts as one digit. Press [Menu/Select] when you are finished.

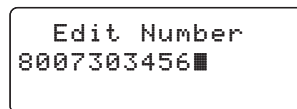

5) Assign a personal ring tone for this entry (PERSONAL RING).

You can attach a special ring tone to each phonebook entry; the phone will use this ring tone when this person calls. Use [▲] and [▼] to select one of the seven different ring tone options (see Selecting a Ring Tone on page 28 for a complete list of ring tones). As you scroll through the tones, you will hear a sample of each tone. When you hear the ring tone you want to use, press [Menu/Select]. If you do not want to use a personal ring tone for this phonebook entry, choose NO SELECTION; the phone will use your standard ring tone setting.

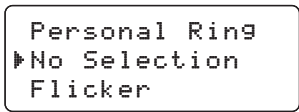

6) You will hear a tone confirming that the new entry has been stored, and DONE! appears in the display.

Finding a Phonebook Entry

Press [Ⓜ] to open the phonebook. Phonebook entries are stored in alphabetical order. To scroll through the phonebook from A to Z, press [▼]. To scroll through the phonebook from Z to A press [▲].

You can also use the letters on the number keys to jump to a name that starts with that letter. For example, to search for an entry beginning with the letter M, press [6] once. The phonebook jumps to the first entry that begins with the letter you entered; you can then use [▲] and [▼] to scroll to other entries.

To close the phonebook, press [Ⓜ]. During a call, press [Ⓜ] again instead of [Ⓜ] to close the phonebook.

Editing an Existing Phonebook Entry

- 1) When the phone is in standby, press [Ⓜ] to open the phonebook.
- 2) Find the entry you want to edit and press [Menu/Select].
- 3) Select EDIT. Follow the steps for Creating Phonebook Entries on page 22. If you do not wish to change the information at any step, simply press [Menu/Select] to go to the next step.

Storing Caller ID or Redial Numbers in the Phonebook

You can store Caller ID records or redial numbers in the phonebook so you can use them later. Go to the Caller ID or redial list and select the number you want to store. (If the Caller ID information did not include the number, then you will not be able to store it.)

- 1) When the phone is in standby, press **[☎]** to open the Caller ID list or **[Redial/Pause]** to open the redial list.
- 2) Use **[▲]** and **[▼]** to scroll through the Caller ID records or redial numbers. When you come to the information you want to store, press **[Menu/Select]**.
- 3) Select STORE INTO PB. EDIT NAME appears. If the phone number is already stored in memory, you will hear a beep, and THIS DATA IS ALREADY SAVED! appears in the display. The number will not be stored.
- 4) Continue by following the steps for Creating Phonebook Entries on page 22.

Deleting Phonebook Entries

You can delete a single phonebook entry at a time or all phonebook entries at once:

To delete a single phonebook entry:

- 1) When the phone is in standby, press **[📄]**.
- 2) Find the entry that you want to delete and press **[Menu/Select]**.
- 3) Select DELETE. DELETE ENTRY? appears in the display.
- 4) Move the cursor to select YES.
- 5) Press **[Menu/Select]**. You will hear a confirmation tone, and DELETED! appears in the display.

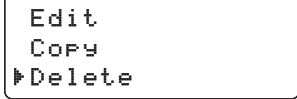

```

Edit
Copy
▶Delete

```

To delete all phonebook entries:

- 1) When the phone is in standby, press **[📄]**.
- 2) Press **[Menu/Select]**, and then select DELETE ALL. DELETE ALL? appears in the display.
- 3) Move the cursor to select YES.
- 4) Press **[Menu/Select]**. You will hear a confirmation tone, and DELETED! appears in the display.

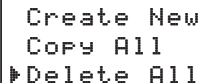

```

Create New
Copy All
▶Delete All

```

Copying Phonebook Entries to Another Handset

If you have more than one handset, you can transfer phonebook entries from one handset to another without having to re-enter names and numbers. You can transfer one phonebook entry at a time or all phonebook entries at once.

- 1) When the phone is in standby, press [**⏏**].
- 2) To copy one entry, find the phonebook entry you want to copy. Press [**Menu/Select**], and then select COPY. To copy all entries, press [**Menu/Select**], and then select COPY ALL.
- 3) Move the cursor to select the handset which you want to transfer the entries to and then press [**Menu/Select**]. If you select COPY ALL, ARE YOU SURE? appears on the display screen. Move the cursor to select YES, and then press [**Menu/Select**].
- 4) The phonebook entries will be transferred to the designated handset. During the copy process, the receiving handset shows RECEIVING and the Handset ID of the sending handset.
- 5) When the transfer is completed, DONE! appears on the handset.

Notes: • The handsets must be currently connected to the same base (see page 21).

- If your phonebook contains seventy entries, you cannot store any new phonebook entries. You will hear a beep, and NOT ENOUGH MEMORY IN RECEIVING UNIT appears on the display. If the selected handset is out of range or data transfer is cancelled, UNAVAILABLE appears in the display. Phonebook listings will not be transferred.

Using the Voice Mail Service

If you subscribe to a voice mail service, you can use your phone to access your voice mailbox. The **new message** LED on the handset flashes and  appears in the handset display whenever you have messages waiting in your voice mailbox. If you have programmed your access number into your phone, you can simply press **[Mute]** to access your voice mail. When you subscribe to the service, your voice mail provider provides you with the access number and the required voice mail signaling tone.

Setting the Voice Mail Signaling Tone

Your telephone service provider should provide you with the specifics of your voice mail service upon your enrollment.

If you are having trouble with your message waiting indicator on your phone not illuminating when you have waiting messages, you will need to contact your service provider and inquire as to which type of message notification signal—either Frequency Shift Keying (FSK) or Stutter Dial Tone (SDT)—their service uses.

If your voice mail service uses an FSK message signal to alert you of a new voice mail message, you must turn off the Voice Mail Tone. If your voice mail service uses an SDT message signal to alert you of new voice mail messages, you can leave the Voice Mail Tone on.

Follow the instructions below to set up your cordless phone settings:

- 1) Press **[Menu/Select]**. Select the GLOBAL SETUP menu, and then the VOICE MAIL TONE submenu.
- 2) Move the cursor to set the voice message indication (SDT message signal) to ON or OFF.
- 3) Press **[Menu/Select]**. You hear a confirmation tone.

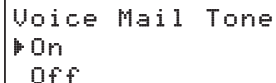

```
Voice Mail Tone
▶ On
  Off
```

Programming One-Touch Voice Mail Access

You can program your voice mail access number to the Voice Mail key [☒/Mute] on each handset so you can get your messages at the touch of a button. Your voice mail service provider will supply you with the access number.

This number may be simply a phone number.

To edit the voice mail number, follow the steps below:

- 1) Press **[Menu/Select]**.
- 2) Move the cursor to select the HANDSET SETUP menu and press **[Menu/Select]**.
- 3) Move the cursor to select EDIT VOICE MAIL and press **[Menu/Select]**.
- 4) Enter your personal access number (up to twenty digits).
- 5) If you need to have the phone wait before sending the next digits, press **[Redial/Pause]** to insert a two-second pause in the dialing sequence. For a longer pause, press **[Redial/Pause]** multiple times. A P appears in the display each time you press **[Redial/Pause]** and each pause counts as one digit.
- 6) Press **[Menu/Select]** when you are finished.

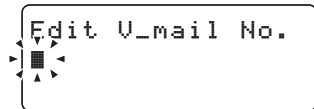

Resetting the Voice Mail Waiting Indicator

When you receive a new voice mail message, the **new message** LED on the top of the handset flashes and VM appears in the handset display. In the event your message alert tone gets out of sync with your phone company's voice messaging system, you can reset back to its original "no messages waiting" state. To reset, press and hold **[find hs]** on the base for five seconds. A beep sounds and the message alert tone is reset.

Customizing Your Phone

Changing the Handset Banner

Each handset will display a banner name once it is registered to the base. The default banner is Handset #1, Handset #2, etc. You can change the name your phone displays by changing the banner display. If you have more than one handset, the banner name identifies your handset.

- 1) Press **[Menu/Select]**. Select the HANDSET SETUP menu, and then the BANNER submenu.
- 2) Use the keypad to enter or edit the banner name. (See Entering Text from Your Handset on page 11 for detailed instructions on entering text.)
- 3) Press **[Menu/Select]**. You will hear a confirmation tone.

Note: When you have multiple bases and even if the handset ID is changed when you switch to a different base, the handset will keep the banner name.

Selecting a Ring Tone

You may choose from four melodies or three tones for your phone's primary ring tone. Each handset can use a different ring tone or melody. The available ring tones are as listed:

- 1) Press **[Menu/Select]**. Select the HANDSET SETUP menu, and then the RINGER TONES submenu.
- 2) Move the cursor to select a ring tone. As each ring tone is highlighted, you will hear a sample.
- 3) When you hear the tone you want to use, press **[Menu/Select]**. You will hear a confirmation tone.

Melodies	Fur Elise (ELISE)	Tones	Flicker
	We Wish You A Merry Christmas (MERRY-XMAS)		Clatter
	Aura Lee (AURA LEE)		Wake Up
	Star Spangled Banner (STAR SPNGL)		

```
Ringer Tones
▶ Flicker
  Clatter
```

Activating AutoTalk

AutoTalk allows you to answer the phone simply by picking up the handset from the cradle. You do not have to press a button to answer the call.

- 1) Press **[Menu/Select]**. Select the HANDSET SETUP menu, and then the AUTOTALK submenu.
- 2) Move the cursor to select ON or OFF.
- 3) Press **[Menu/Select]**. You will hear a confirmation tone.

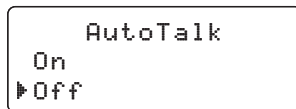

Activating Any Key Answer

Any Key Answer allows you to answer the phone by pressing any key on the dial pad.

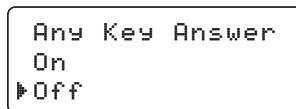

- 1) Press **[Menu/Select]**. Select the HANDSET SETUP menu, and then the ANY KEY ANSWER submenu.
- 2) Move the cursor to select ON or OFF.
- 3) Press **[Menu/Select]**. You will hear a confirmation tone.





Using Your Phone

	From a cordless handset	From a handset speaker phone
Making a call	1) Pick up the handset from the cradle. 2) Press [*/Flash] . 3) Listen for the dial tone. 4) Dial the number. OR 1) Pick up the handset from the cradle. 2) Dial the number. 3) Press [*/Flash] .	1) Pick up the handset from the cradle. 2) Press [*☎] . 3) Listen for the dial tone. 4) Dial the number. OR 1) Pick up the handset from the cradle. 2) Dial the number. 3) Press [*☎] .
Answering a call	1) Pick up the handset. (If AutoTalk is on, the phone will answer when you pick up the handset from the cradle.) 2) Press [*/Flash] . (If Any Key Answer is on, you can also press any key on the dial pad.)	1) Pick up the handset. 2) Press [*☎] .
Hanging up	Press [*])] or return the handset to the cradle.	Press [*])] or return the handset to the cradle.



Making a Call from the Phonebook

- 1) When the phone is in standby, press [] to open the phonebook.
- 2) Find the phonebook entry you want to call (see Finding a Phonebook Entry on page 23).
- 3) Press [ /Flash] or [] to dial the number.



Note: You can also press [ /Flash] or [] before you open the phonebook. When you come to the phone number you want to dial, press [Menu/Select].

Chain Dialing from the Phonebook

You can use the phonebook entries to store a group of numbers (up to twenty digits) that you may need to enter once your call connects.

- 1) Dial the number normally.
- 2) After the call connects, press [].
- 3) Use [] or [] to select the phonebook entry that contains the digits you want to send.
- 4) Press [Menu/Select].

Switching to the Handset Speakerphone During a Call

To switch a normal call to the speakerphone, press []. To switch from a speakerphone call to a normal call, press [].

Using Caller ID, Call Waiting, and Redial Lists

If you subscribe to Caller ID service from your phone company, your phone will show you the caller's phone number and name (if available) whenever a call comes in. If you subscribe to Caller ID on Call Waiting, the phone will also show you the name and the number of any call that comes in while you're on the line.

If your telephone provider supports seven-digit dialing, you can save your local area code so it does not display in the Caller ID list. See Seven-Digit Dialing on page 38 for more information.

Using the Caller ID List

You can store up to thirty Caller ID numbers in each handset. Caller ID records are stored from newest to oldest. Once your Caller ID list is full, the oldest record will be automatically deleted when a new call is received.

To open the Caller ID list, press **[*IP]** (on the right side of the four-way key). The phone will show the number of new Caller ID records and the total number of stored records. Use **[▲]** and **[▼]** to scroll through the list.

```
Caller ID
New : 1
Total:30
```

```
12/21 12:00PM
Jane Smith
214-555-1234
```

Making a Call from a Caller ID Record

- 1) When the phone is in standby, press **[*IP]** to open the Caller ID list.
- 2) Use **[▲]** and **[▼]** to find the Caller ID record you want to dial.
- 3) To add (or delete) a "1" to the beginning of the displayed phone number, press **[*/tone]**.
- 4) Press **[[/Flash]** or **[*]]** to dial the number.

Note: You can also press **[[/Flash]** or **[*]]** before you open the caller ID list. When you come to the phone number you want to dial, press **[Menu/Select]**.

Deleting Caller ID Numbers

To delete only one Caller ID number, press **[[*]]** when the phone is in standby, and then find the number you want to delete. Press **[Menu/Select]** and select DELETE ENTRY. When the phone asks you to confirm, select YES.

To delete all the Caller ID numbers, press **[[*]]** when the phone is in standby, and then press **[Menu/Select]**. When the phone asks you to confirm, select YES.

Note: When you delete a Caller ID number, you delete it permanently.

Using Call Waiting

If you have Call Waiting service and a second call comes in when you are on the phone, a call waiting tone will sound. Press **[*/Flash]** to accept the waiting call. There is a short pause, and then you will hear the new caller. To return to the original caller, press **[*/Flash]**.

Note: You must subscribe to Call Waiting service for this feature to operate. Not all features are available in all areas.

Redialing a Number

You can quickly redial the last five numbers dialed on each handset.

- 1) When the phone is in standby, press the **[Redial/Pause]** to open the redial list.
- 2) Use **[▲]** and **[▼]** or **[Redial/Pause]** to scroll through the redial list.
- 3) When you find the number you want to dial, press **[*/Flash]** or **[▶▶]**.

Notes:

- If the number exceeds 32 digits, only the first 32 digits are retained in redial memory.
- If the redial memory is empty, EMPTY appears in the display and you will hear a beep.
- You can also press **[*/Flash]** or **[▶▶]** before you open the redial list. When you come to the phone number you want to dial, press **[Menu/Select]**.

Deleting a Redial Record

If you want to delete a phone number from the handset's redial list, follow the steps below:

- 1) When the phone is in standby, press **[Redial/Pause]**.
- 2) Use **[▲]** and **[▼]** to scroll through the redial list.
- 3) When you find the redial number you want to delete, press **[Menu/Select]** and select DELETE ENTRY.
- 4) When the phone asks you to confirm, select YES. The redial number is deleted.

Adjusting the Ringer, Earpiece and Speaker Volume

Adjusting the Ringer Volume

You can choose from four ringer volume settings (off, low, medium, and high) on the handset. With the phone in standby, use **[▲]** to make the ringer volume louder or **[▼]** to make it softer or turn it completely off.

Adjusting the Earpiece Volume

You can choose from six volume levels for the earpiece. To adjust the earpiece volume while on a call, press **[▲]** (to make it louder) or **[▼]** (to make it softer).

Adjusting the Speaker Volume

You can choose from six volume levels for the handset speakerphone. To adjust the speaker volume while on a speakerphone call, press **[▲]** (to make it louder) or **[▼]** (to make it softer).

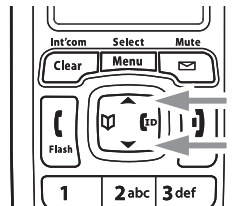

Adjusting the Audio Tone

If you aren't satisfied with the audio quality of your phone, you can adjust the Audio Tone of the earpiece while on a call. Your phone gives you three audio tone options: low, natural and high; the default setting, Natural Tone, is recommended for hearing aid users. Audio tone adjustments only apply to the earpiece, not the speakerphone.

To adjust the audio tone:

- 1) While on a call, press **[Menu/Select]**.
- 2) Move the cursor to select AUDIO TONE, and then press **[Menu/Select]**.
- 3) Move the cursor to select desired option (HIGH TONE, NATURAL TONE, or LOW TONE), and then press **[Menu/Select]**. Selected option appears in the display for two seconds, and then the display returns to normal.

Finding a Lost Handset

To locate a misplaced handset, press **[find hs]** on the base when the phone is in standby. The handsets connected to the paging base will beep for one minute, and PAGING appears on the handset display. To cancel paging, press **[find hs]** again or any key on the found handset.

Note: Handsets that are not currently connected to this base will not be paged.

Using Hold, Conference and Transfer

Placing a Call on Hold

- 1) During a call, press **[Clear/Int'com]** on the handset to place the caller on hold. If you leave a caller on hold for more than ten seconds, the display screen will read, Line On Hold.
- 2) To return to the party on hold, press **[Flash]** or **[Mute]** on a handset. The phone will return to the holding party.

Notes:

- You can only place a caller on hold for five minutes. Once five minutes has passed, that party's line will be disconnected and the phone will return to standby.

- While a call is on hold, Caller ID and Call Waiting cannot be received.

Conferencing

If you have more than one handset, up to three people can participate in a conference call. A three-way conference call consists of an outside line and two handsets. You can easily join a call already in progress. The handsets must be currently connected to the same base (see page 21).

- 1) Press **[*/Flash]** or **[*M]** to join the call.
- 2) To hang up, return the handset to the cradle or press **[*]**. The other party will still be connected to the call.

Transferring a Call

You can transfer a call from one handset to another. The handsets must be currently connected to the same base (see page 21).

- 1) During a call, press **[Clear/Int'com]**.
- 2) Use **[▲]** or **[▼]** to select the handset you want to transfer the call to, and then press **[Menu/Select]**. Select ALL to page all other handsets. The call will automatically be placed on hold, and a paging tone sounds. To cancel the transfer, press **[*/Flash]** or **[*M]**.
- 3) When another handset accepts the transferred call, you will be disconnected. If you want to rejoin the call, press **[*/Flash]** again or **[*M]**.

Answering a Transferred Call

When a handset receives a call transfer, it sounds a paging tone; handsets also show the ID of the handset that is paging. To accept the call transfer:

- 1) To answer the page and speak to the transferring handset, press **[*/Flash]** or **[Clear/Int'com]**.
- 2) To accept the call and speak to the caller, press **[*/Flash]**.
- 3) When you accept the transferred call, the transferring handset will be disconnected.

Only the first handset to answer the transfer page will be connected to the call. If the transfer page is not picked up within one minute, the operation will be canceled.

Using Special Features

Privacy Mode

If you don't want other handsets to interrupt you while on a call, turn on privacy mode. As long as your handset is in privacy mode, other handsets can't join your call or make any calls of their own: their displays will show UNAVAILABLE.

- 1) While on a call, press **[Menu/Select]**.
- 2) Select CALL PRIVACY. PRIVACY MODE ON appears in the display for two seconds; \bar{F} appears and remains in the display until the feature is turned off.

To turn privacy mode off, repeat the procedure listed above. PRIVACY MODE OFF appears.

Using the Intercom

You can use the intercom to talk to another handset without using the phone line. The handsets must be currently connected to the same base (see page 21).

Making an Intercom Page

- 1) When the phone is in standby, press **[Clear/Int'com]**.
- 2) Use **[▲]** or **[▼]** to select the handset you want to talk with, and then press **[Menu/Select]**. Select ALL to page all other handsets.
- 3) To cancel the intercom page, press **[*]**.

Note: Intercom paging will be cancelled if any of the following things occur:

- You receive an outside call or an intercom page while selecting the other handset.
- You do not select a handset within thirty seconds.
- Your handset is out of range (OUT OF RANGE appears in the display).
- The party does not answer the page within one minute.
- The party is busy.
- The party is out of range (UNAVAILABLE appears in the display).

Answering an Intercom Page

When the intercom page tone sounds, the display will show the ID of the handset that is paging.



- 1) Press **[*/Flash]** or **[Clear/Int'com]**. If AutoTalk is on, the handset will automatically answer the page when you pick up the handset from the cradle.
- 2) To hang up an intercom call, press **[*]**.

Muting the Ringer (One call only)

While the phone is ringing, press **[*]** to mute the ringer for this call. The phone will ring again on the next call.

Muting the Microphone

Mute turns off the microphone so the caller can't hear you. This only works while you are on a call.

- 1) Press **[M/Mute]**. MUTE ON and  appear in the display;  remains while muting is on.
- 2) To cancel muting, press **[M/Mute]** again. MUTE OFF appears.

Seven-Digit Dialing

In some areas, the telephone company may allow you to place a local call by dialing only seven digits (instead of ten). If this is the case in your area, you can program your local area code in your phone. Programming your area code will allow you to see the caller's seven-digit phone number which will allow you to easily return the local call without modifying the number before dialing. If you get a call from outside your area code, you will see all ten digits.

To program your local area code:

- 1) Press **[Menu/Select]**. Select the GLOBAL SETUP menu, and then the AREA CODE submenu.
- 2) Use the number keypad (**[0]** through **[9]**) to enter a three-digit area code. If an area code has already been stored, it appears in the display. Press **[Clear/Int'com]** to delete the stored code, and then enter a new one.
- 3) Press **[Menu/Select]**. You will hear a confirmation tone.

Note: If you have multiple bases, select the base before programming the area code (see page 21).

Tone Dialing Switch Over

If your phone is set to pulse dialing, you can temporarily switch to tone dialing after the call connects. This feature is useful when you need tone dialing to use automated menu systems, such as telephone bank tellers, telephone prescription refills, customer support menus, etc. Make your call normally. Once your call connects, press **[* /tone]** on the handset. Any digits you enter from then on will be sent with tone dialing. When this particular call ends, the phone automatically returns to pulse dialing.

See Changing the Dial Mode on page 15 for instructions on setting your phone for pulse or tone dialing.

Line Mode Setup (Base only)

The Line Mode Setup feature is only used in instances where you have multiple phones where users may pick up an extension while someone else is on the phone. Only in very rare instances where your phone system is not detecting that an extension phone is picked up will you ever need to change this feature. There are three settings for this feature: TYPE-A, TYPE-B, or OFF, but change this option only when instructed to by customer service. In most all situations, this feature will never need to be used or modified from the factory default setting of TYPE-A.

- 1) If you have multiple bases, select the base you need to change the setting (see page 21).
- 2) Press **[Menu/Select]**. Select the GLOBAL SETUP menu, and then the SET LINE MODE submenu.
- 3) IF INSTRUCTED BY CUSTOMER SERVICE PRESS [SELECT] appears. Press **[Menu/Select]**.
- 4) Move the cursor to select TYPE - A, TYPE - B, or OFF.
- 5) Press **[Menu/Select]**. You will hear a confirmation tone.

Installing the Optional Headset

Your phone may be used with an optional headset. To use this feature, insert the headset plug into the headset jack. Your phone is ready for hands-free conversations. (Headsets may be purchased by calling the Uniden Parts Department. See inside the back cover page for contact information.)



Maintenance

Specifications

Operating Temperature	32° F to 122° F (0° C to 50° C)
AC Adapter Part Number	Base: AD-800 Charger: AD-0005
AC Adapter Input Voltage	Base: 120V AC, 60 Hz Charger: 120V AC, 60 Hz
AC Adapter Output Voltage	Base: 9V DC @ 350mA Charger: 9V DC @ 210mA
Battery Part Number	BT-1008
Battery Capacity	2.4V DC @ 650mAh

Notes:

- Use only the supplied AC adapters.
- Be sure to use the proper adapter for the base and any chargers.
- Do not place the power cord where it creates a trip hazard or where it could become chafed and create a fire or electrical hazard.
- Do not place the base in direct sunlight or subject it to high temperatures.

Battery Replacement and Handling

With average use, your phone's battery should last approximately one year. To order replacement batteries, please contact Uniden's Parts Department. The contact information is listed inside the back cover page.

Caution:

- Use only battery pack BT-1008.
- Do not remove the batteries from the handset to charge them.
- Never throw the battery into a fire, disassemble, or heat them.
- Do not remove or damage the battery casing.

Cleaning the Battery Contacts

To maintain a good charge, clean the charging contacts on the handset once a month. Dampen a cloth with plain water. Gently rub the damp cloth over the charging contacts until all visible dirt is removed. Dry the contacts thoroughly before returning the handset to the cradle.

Caution: Do not use paint thinner, alcohol, or other chemical products. Doing so may discolor the surface of the telephone and damage the finish.

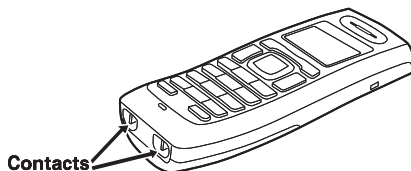

Low Battery Alert

When the battery pack is very low, the phone is programmed to eliminate functions in order to save power. When LOW BATTERY appears in the display and the phone is in standby, none of the keys will operate. If you are on a call, complete your conversation as quickly as possible, and return the handset to the cradle.

The battery pack needs to be charged when the empty battery icon appears.

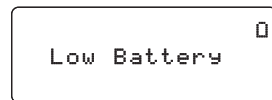

Battery Life

With average use, your handset battery provides approximately ten hours of talk time and approximately seven days of standby time. You can achieve optimum battery life and performance by returning the handset to the base or charger after each use. When your handset is left off of the cradle, the battery will gradually discharge even if the handset is not being used. The actual talk time duration will be reduced in proportion to the amount of time the handset is off of the cradle.

Power Failures

During a power failure, you will not be able to make or receive calls with the phone. To avoid damage from an electrical spike when the power comes back on, we recommend you unplug your phone during power outages.

Troubleshooting

Resetting the Handset

You may need to reset your handset in the following instances:

- You lose a handset and purchase a new one.
- You get the message Registration Failed when you try to register the handset.
- You are unable to register any handsets to the base.
- When you register new handsets to the base, the handset IDs do not match. (For example, the handset registers as “Handset #4” but you only have two handsets.)
- When you are instructed to by one of Uniden’s call center representatives.

- 1) Select the base you want to de-register the handset from (see Selecting the Base on page 21).
- 2) Press and hold **[*]** and **[#]** for more than five seconds. Select DEREGISTER HS.
- 3) Select the handset which you are operating, and then press **[Menu/Select]**.
- 4) The phone will ask you to confirm the deregistration. Select YES. The selected handset will clear its registration information only from the base it is currently connected to, and then delete the link to the base from its own memory.
- 5) When the base information is deleted, the handset displays HANDSET NOT REGISTERED-PLACE HANDSET ON BASE TO REGISTER. SEE YOUR OWNER’S MANUAL FOR HELP.
- 6) Re-register the handset to the base (see Registering Accessory Handsets on page 20).

If the handset cannot contact the base, it will display OUT OF RANGE. Make sure the handset is in range of the base and the base is connected to power; you can also reset the handset without the base (see page 43).

Resetting the Handset Without the Base

If your original base is not available for some reason, you can still reset the handset and use it with another base.

- 1) Press and hold **[*]** and **[#]** for at least five seconds.
- 2) Move the cursor to select BASEUNAVAILABLE and then press **[Menu/Select]**. BASE UNAVAILABLE appears.
- 3) Select the base which you want to de-register from, and then press **[Menu/Select]**.
- 4) Move the cursor to select YES, and then press **[Menu/Select]**. You hear a confirmation tone, and the handset deletes its own base information without contacting the base. The handset displays HANDSET NOT REGISTERED-PLACE HANDSET ON BASE TO REGISTER. SEE YOUR OWNER'S MANUAL FOR HELP.
- 5) Register the handset to the new base (see Registering Accessory Handsets on page 20).

Traveling Out of Range

During a call, if you move your handset too far from your base, noise may increase. If you pass the range limit of the base, the handset will beep, display OUT OF RANGE, and then go to standby. The base will maintain the connection for thirty seconds after the handset goes out of range. If you move the handset back within range of the base within thirty seconds, press **[*/Flash]** or **[*]]]** to pick up the call again.

Note: If it is set to automatically select the available base, the handset will begin searching for another base thirty seconds after going out of range. (see Selecting the Base on page 21).

Common Issues

If your phone is not performing to your expectations, please try these simple steps first. If these steps do not solve your problem, please call our Customer Hotline (see At Uniden, we'll take care of you! inside the back cover).

Symptom	Suggestion
The charge LED won't illuminate when the handset is placed in the cradle.	<ul style="list-style-type: none">• Make sure the AC adapter is plugged into the base or the charger (if you have more than one handset) and wall outlet.• Make sure the AC outlet is not connected to a wall switch.• Make sure the handset is properly seated in the cradle.• Make sure the charging contacts on the handset are clean.
The audio sounds weak.	<ul style="list-style-type: none">• Move the handset and/or base away from metal objects or appliances.• Make sure that you are not too far from the base.
Can't make or receive calls.	<ul style="list-style-type: none">• Make sure that you are not too far from the base.• Make sure the line is not in use. If an outside call is already using a line, you cannot use that line to make another outside call.• Make sure your handset is registered to the base.• Check both ends of the base telephone cord.• Make sure the AC adapter is plugged into the base and wall outlet.• Disconnect the AC adapter and reconnect.
Severe noise interference.	<ul style="list-style-type: none">• Keep the handset away from microwave ovens, computers, remote control toys, wireless microphones, alarm systems, intercoms, room monitors, fluorescent lights, and electrical appliances.• Move to another location or turn off the source of interference.
The Caller ID does not display.	<ul style="list-style-type: none">• The call was placed through a switchboard.• Call your telephone provider to verify your Caller ID service is current. There may be a problem with your Caller ID service.

Symptom	Suggestion
The handset doesn't ring or receive a page.	<ul style="list-style-type: none"> • Make sure that you are not too far from the base. • Make sure that your handset is registered to the base. • Charge the battery in the handset for 15 to 20 hours.
You cannot register the handset at the base.	<ul style="list-style-type: none"> • Charge the battery pack in the handset for 15 to 20 hours. • Try resetting the handset (see Resetting the Handset on page 42).
The handset doesn't communicate with other handsets.	<ul style="list-style-type: none"> • Make sure that you have registered all handsets to the same base, and all handsets are selecting the base (see page 21).
An extra handset can't join the conversation.	<ul style="list-style-type: none"> • Make sure there are not two handsets already using the conference feature. • Make sure that another handset is not in privacy mode. • Make sure that you have registered both handsets to the same base, and both handsets are selecting the base (see page 21).
The Voice Mail Waiting LED flashes, but there are no new messages.	<ul style="list-style-type: none"> • Reset the Voice Mail Waiting Indicator (see page 27).

Liquid Damage

Moisture and liquid can damage your cordless phone.

- If the handset or base is exposed to moisture or liquid, but only the exterior plastic housing is affected, wipe off the liquid, and use as normal.
- If moisture or liquid has entered the plastic housing (i.e. liquid can be heard in the phone or liquid has entered the handset battery compartment or vent openings on the base), follow the steps below:

Handset	Base
<ol style="list-style-type: none">1) Remove the battery cover and leave it off for ventilation.2) Disconnect the battery pack. Leave the battery cover off and the battery pack disconnected for at least 3 days.3) Once the handset is completely dry, reconnect the battery pack and the battery cover.4) Recharge the handset's battery pack for 15 to 20 hours before using.	<ol style="list-style-type: none">1) Disconnect the AC adapter from the base, cutting off electrical power.2) Disconnect the telephone cord from the base.3) Let dry for at least 3 days.

IMPORTANT: You must unplug the telephone line while recharging the battery packs to avoid charge interruption.

CAUTION: **DO NOT use a microwave oven to speed up the drying process. This will cause permanent damage to the handset, base and the microwave oven. After following these steps, if your cordless telephone does not work, please call our Customer Service Hotline (see inside the back cover page).**

Precautions!

Before you read anything else, please observe the following:

Warning!

Uniden America Corporation DOES NOT represent this unit to be waterproof. To reduce the risk of fire, electrical shock, or damage to the unit, DO NOT expose this unit to rain or moisture.

Rechargeable Nickel-Metal-Hydride Battery Warning

- This equipment contains a rechargeable Nickel-Metal-Hydride battery.
- The rechargeable batteries contained in this equipment may explode if disposed of in a fire.
- Nickel is a chemical known to state of California to cause cancer.
- Do not short-circuit the battery.
- Do not charge the rechargeable battery used in this equipment in any charger other than the one designed to charge this battery as specified in the owner's manual. Using another charger may damage the battery or cause the battery to explode.

Rechargeable Batteries Must Be Recycled or Disposed of Properly.

Uniden works to reduce lead content in our PVC coated cords in our products and accessories.

Warning!

The cords on this product and/or accessories contain lead, a chemical known to the State of California to cause birth defects or other reproductive harm. Wash hands after handling.

Important Safety Instructions

When using your telephone equipment, basic safety precautions should always be followed to reduce the risk of fire, electric shock and injury to persons, including the following:

1. Do not use this product near water, for example, near a bath tub, wash bowl, kitchen sink or laundry tub, in a wet basement or near a swimming pool.
2. Avoid using a telephone (other than a cordless type) during an electrical storm. There may be a remote risk of electric shock from lightning.
3. Do not use the telephone to report a gas leak in the vicinity of the leak.
4. Use only the power cord and batteries indicated in this manual. Do not dispose of batteries in a fire. They may explode. Check with local authorities for possible battery disposal instructions.
5. Do not disassemble any component of this product.

SAVE THESE INSTRUCTIONS

CAUTION

Risk of explosion if battery is replaced by an incorrect type. Dispose of used batteries according to the instructions. Do not open or mutilate the battery, and disconnect the battery before shipping this product.

The FCC Wants You To Know

This equipment complies with Part 68 of the FCC rules and the requirements adopted by the ACTA. On the bottom of this equipment is a label that contains, among other information, a product identifier in the format US:AAAEQ##TXXXX. If requested, this number must be provided to the telephone company.

An applicable Universal Service Order Codes (USOC) certification for the jacks used in this equipment is provided (i.e., RJ11C) in the packaging with each piece of approved terminal equipment. A plug and jack used to connect this equipment to the premises wiring and telephone network must comply with the applicable FCC Part 68 rules and requirements adopted by the ACTA. A compliant telephone cord and modular plug is provided with this product. It is designed to be connected to a compatible modular jack that is also compliant. See installation instructions for details.

The REN is used to determine the number of devices that may be connected to a telephone line. Excessive RENs on a telephone line may result in the devices not ringing in response to an incoming call. In most but not all areas, the sum of RENs should not exceed five (5.0). To be certain of the number of devices that may be connected to a line, as determined by the total RENs, contact the telephone provider. For products approved after July 23, 2001, the REN for this product is part of the product identifier that has the format US:AAAEQ##TXXXX. The digits represented by ## are the REN without a decimal point (e.g., 03 is a REN of 0.3). For earlier products, the REN is separately shown on the label.

If this equipment causes harm to the telephone network, the telephone company will notify you in advance that temporary discontinuance of service may be required. But if advance notice isn't practical, the telephone company will notify the customer as soon as possible. Also, you will be advised of your right to file a complaint with the FCC if you believe it is necessary. The telephone company may make changes in its facilities, equipment, operations or procedures that could affect the operation of the equipment. If this happens the telephone company will provide advance notice in order for you to make necessary modifications to maintain uninterrupted service.

Please follow instructions for repairing, if any (e.g. battery replacement section); otherwise do not substitute or repair any parts of the device except as specified in this manual. Connection to party line service is subject to state tariffs. Contact the state public utility commission, public service commission or corporation commission for information. This equipment is hearing aid compatible.

Should you experience trouble with this equipment, please contact Uniden customer service at 800-297-1023. If the equipment is causing harm to the telephone network, the telephone company may request that you disconnect the equipment until the problem is resolved.

NOTICE: According to telephone company reports, AC electrical surges, typically resulting from lightning strikes, are very destructive to telephone equipment connected to AC power sources. To minimize damage from these types of surges, a surge arrestor is recommended.

Changes or modifications to this product not expressly approved by Uniden, or operation of this product in any way other than as detailed by the owner's manual, could void your authority to operate this product.

This device complies with part 15 of the FCC rules. Operation is subject to the following two conditions: (1) This device may not cause harmful interference, and (2) This device must accept any interference received, including interference that may cause undesired operation. Privacy of communications may not be ensured when using this phone.

To insure the safety of users, the FCC has established criteria for the amount of radio frequency energy various products may produce depending on their intended usage. This product has been tested and found to comply with the FCC's exposure criteria. For body worn operation, the FCC RF exposure guidelines were also met when used with the Uniden accessories supplied or designed for this product. Use of other accessories may not ensure compliance with FCC RF exposure guidelines and should be avoided.

The antenna(s) used for the base-unit must be installed to provide a separation distance of at least 20 cm from all persons and must not be collocated or operated in conjunction with any other antenna or transmitter.

Radio Interference

Radio interference may occasionally cause buzzing and humming in your cordless handset, or clicking noises in the base. This interference is caused by external sources such as TV, refrigerator, vacuum cleaner, fluorescent lighting, or electrical storm. Your unit is NOT DEFECTIVE. If these noises continue and are too distracting, please check around your home to see what appliances may be causing the problem. In addition, we recommend that the base not be plugged into a circuit that also powers a major appliance because of the potential for interference. Be certain that the antenna on the unit is fully extended when needed. In the unlikely event that you consistently hear other voices or distracting transmissions on your phone, you may be receiving radio signals from another cordless telephone or other source of interference. If you cannot eliminate this type of interference, you need to change to a different channel.

Finally, it should be noted that some cordless telephones operate at frequencies that may cause interference to nearby TVs and VCRs. To minimize or prevent such interference, the base of the cordless telephone should not be placed near or on top of a TV or VCR. If interference is experienced, moving the cordless telephone farther away from the TV or VCR will often reduce or eliminate the interference.

Cordless Telephone Privacy

Cordless telephones are radio devices. Communications between the handset and base of your cordless telephone are accomplished by means of radio waves which are broadcast over the open airways. Because of the inherent physical properties of radio waves, your communications can be received by radio receiving devices other than your own cordless telephone unit. Consequently, any communications using your cordless telephone may not be private.

I.C. Notice

Terminal Equipment

NOTICE: This equipment meets the applicable Industry Canada Terminal Equipment Technical Specifications. This is confirmed by the registration number. The abbreviation, IC, before the registration number signifies that registration was performed based on a Declaration of Conformity indicating that Industry Canada technical specifications were met. It does not imply that Industry Canada approved the equipment.

NOTICE: The Ringer Equivalence Number (REN) for this terminal equipment is marked on the equipment itself. The REN assigned to each terminal equipment provides an indication of the maximum number of terminals allowed to be connected to a telephone interface. The termination on an interface may consist of any combination of devices subject only to the requirement that the sum of the Ringer Equivalence Numbers of all the devices does not exceed five.

Radio Equipment

The term "IC:" before the radio certification number only signifies that Industry Canada technical specifications were met.

Operation is subject to the following two conditions: (1) this device may not cause interference, and (2) this device must accept any interference, including interference that may cause undesired operation of the device. "Privacy of communications may not be ensured when using this telephone."

One Year Limited Warranty

Important: Evidence of original purchase is required for warranty service. **WARRANTOR:** UNIDEN AMERICA CORPORATION ("Uniden") **ELEMENTS OF WARRANTY:** Uniden warrants, for one year, to the original retail owner, this Uniden Product to be free from defects in materials and craftsmanship with only the limitations or exclusions set out below. **WARRANTY DURATION:** This warranty to the original user shall terminate and be of no further effect 12 months after the date of original retail sale. The warranty is invalid if the Product is (A) damaged or not maintained as reasonable or necessary, (B) modified, altered, or used as part of any conversion kits, subassemblies, or any configurations not sold by Uniden, (C) improperly installed, (D) serviced or repaired by someone other than an authorized Uniden service center for a defect or malfunction covered by this warranty, (E)

used in any conjunction with equipment or parts or as part of any system not manufactured by Uniden, or (F) installed or programmed by anyone other than as detailed by the owner's manual for this product. **STATEMENT OF REMEDY:** In the event that the product does not conform to this warranty at any time while this warranty is in effect, warrantor will either, at its option, repair or replace the defective unit and return it to you without charge for parts, service, or any other cost (except shipping and handling) incurred by warrantor or its representatives in connection with the performance of this warranty. Warrantor, at its option, may replace the unit with a new or refurbished unit. **THE LIMITED WARRANTY SET FORTH ABOVE IS THE SOLE AND ENTIRE WARRANTY PERTAINING TO THE PRODUCT AND IS IN LIEU OF AND EXCLUDES ALL OTHER WARRANTIES OF ANY NATURE WHATSOEVER, WHETHER EXPRESS, IMPLIED OR ARISING BY OPERATION OF LAW, INCLUDING, BUT NOT LIMITED TO ANY IMPLIED WARRANTIES OF MERCHANTABILITY OR FITNESS FOR**

A PARTICULAR PURPOSE. THIS WARRANTY DOES NOT COVER OR PROVIDE FOR THE REIMBURSEMENT OR PAYMENT OF INCIDENTAL OR CONSEQUENTIAL DAMAGES.

Some states do not allow this exclusion or limitation of incidental or consequential damages so the above limitation or exclusion may not apply to you.

LEGAL REMEDIES: This warranty gives you specific legal rights, and you may also have other rights which vary from state to state. This warranty is void outside the United States of America and Canada. **PROCEDURE FOR OBTAINING PERFORMANCE OF WARRANTY:** If, after following the instructions in the owner's manual you are certain that the Product is defective, pack the Product carefully (preferably in its original packaging). Disconnect the battery from the Product and separately secure the battery in its own separate packaging within the shipping carton. The Product should include all parts and accessories originally packaged with the Product. Include evidence of original purchase and a note describing the defect that has caused you to return it. The Product should be shipped freight prepaid, by traceable means, to warrantor at:

Uniden America Service

4700 Amon Carter Blvd.

Fort Worth, TX 76155

Index

A

Accessibility	4
Answering calls.....	30
Any key answer	29
Area code	38
AutoTalk.....	29

B

Banner.....	28
Base	
Installing	14
Multiple Bases.....	20
Parts of the base.....	8
Wall mounting	16
Battery	
Battery life	41
Installing	13
Low battery alert.....	41
Replacement and handling	40
Belt clip.....	14

C

Caller ID.....	32
Deleting Caller ID records.....	33
Making calls from	32
Call waiting	33
Chain dialing.....	31
Conferencing	36

D

Dial mode	15, 39
-----------------	--------

F

FCC statements.....	48
Finding a handset.....	35

H

Handset	
Accessory handsets	19
Banner.....	28
Choosing a ringer.....	28
Copying phonebook entries	25
Display and icons	9
Entering text.....	11
Finding	35
Parts of the handset.....	7
Registering	20, 21
Resetting	42

Standby screen	9
Hanging up	30
Headset	39
Hold	35

I

Installation	12
Intercom.....	37

K

Key touch tone.....	18
---------------------	----

M

Maintenance	40
Making calls.....	30
Using Caller ID	32
Using redial	33
Using the phonebook	31
Multiple Bases	20
Mute	
Microphone	38
Ringer.....	38

O

Out of range.....	43
-------------------	----

P		T	
Personal ring	17	Text, entering	11
Phonebook	22	Tone dialing	15, 39
Copying entries	25	Transferring a call	36
Creating new entries	22		
Deleting entries	24	V	
Editing entries	23	Voice Mail	26
Finding entries.....	23	Programming.....	27
Making a call from	31	Tone	26
Storing Caller ID or redial		Waiting Indicator Reset	27
numbers	24	Volume, adjusting	34
Privacy mode.....	37		
Pulse dialing	15, 39	W	
		Wall mounting the base	16
R		Warranty	50
Redial			
Deleting a record.....	34		
Making a calls with	33		
Ringer			
Muting	38		
Personal ring	17		
S			
Safety notices.....	47		
Selecting the base	21		
Seven-digit dialing	38		

Memo

At Uniden, we'll take care of you!

Thank you for purchasing a Uniden product. If you have any questions or problems, please do not return this product to the place of purchase.

Having trouble?	Our customer care specialists are here to help you! Visit our web-site at www.uniden.com or call our Customer Service Hotline at 1-800-297-1023 during regular business hours.*
Need a part?	To order headsets, accessory handsets, replacement batteries, or other accessories, visit our website at www.uniden.com or call 1-800-554-3988 during regular business hours.*
Help for our customers with special needs	If you need special assistance due to a disability or have questions on the accessibility features of this product, please call 1-800-874-9314 (voice or TTY) .

* Central Standard Time. Detailed customer service hours are available at www.uniden.com.

May be covered under one or more of the following U.S. patents:

4,797,916	5,426,690	5,434,905	5,491,745	5,493,605	5,533,010	5,574,727	5,581,598
5,650,790	5,660,269	5,661,780	5,663,981	5,671,248	5,696,471	5,717,312	5,732,355
5,754,407	5,758,289	5,768,345	5,787,356	5,794,152	5,801,466	5,825,161	5,864,619
5,893,034	5,912,968	5,915,227	5,929,598	5,930,720	5,960,358	5,987,330	6,044,281
6,070,082	6,125,277	6,253,088	6,314,278	6,418,209	6,618,015	6,671,315	6,714,630
6,782,098	6,788,920	6,788,953	6,839,550	6,889,184	6,901,271	6,907,094	6,914,940
6,953,118	7,023,176	7,030,819	7,146,160				

Other patents pending.

Uniden[®] | A World Without Wires[®]

VISIT
WWW.UNIDEN.COM
TO REGISTER YOUR
PRODUCT

© 2007 Uniden America Corp., Fort Worth, Texas. Contains additional foreign articles. Printed in China.

UCZZ01509BZ(0)